

Issue 03 Julv 2007

Sigma Si

Extinguishant Status Unit

Operation and Maintenance Manual



DOCUMENT REFERENCE K7247-01 (Man-1089)

MODEL NUMBERS

K91100055, K91100056, K91110055, K91110056
K91111055, K91111056, K911113 55, K911113 56

Index

Section	Page
1. Introduction	3
2. Safety and mounting	3
2.1 Safety	3
2.2 Mounting	4
3. Technical specification	4
4. Status Unit fascia.....	5
5. Connecting to the circuit board	7
6. Power and data connections	8
7. Connection to Hold and Mode inputs	9
8. Mode input	9
9. Hold input.....	9
10. Mode select keyswitch	10
11. Manual release	10
12. Addressing status units.....	10
13. Processor and watchdog reset switches	10
14. Internal fault indications	10
14.1 COM.....	11
14.2 HOL.....	11
14.3 MOD.....	11
14.4 FUSE	11
15. Adding new status units/ancillary boards	12
16. Removing status units	12

1. Introduction

The Sigma-SI Status Units are designed in accordance with European standard EN12094-1 Fixed firefighting systems - Components for gas extinguishing systems - Part 1: Requirements and test methods for electrical automatic control and delay devices.

The Status Units are designed to extend the indications and some controls of Sigma XT extinguishant control panels to other locations within the fire protection system to make operation of the system more practical within areas that have multiple access points (or doors). A maximum of seven status units may be connected to each control panel extinguishant area.

All units connect to a two wire data communications bus and are powered by the Auxiliary 24V DC output of compatible, extinguishant control panels.

In addition to the requirements of EN12094-1 status units have the following facilities:

.....*Signal representing the flow of extinguishing agent* to indicate the released condition. EN12094-1 Section 4.18 option with requirements.

.....*Monitoring of the status of components* by way of a low pressure switch input. EN12094-1 Section 4.19 option with requirements.

.....*Emergency hold device* to enable the extinguishant delay time to be extended. EN12094-1 Section 4.20 option with requirements.

.....*Manual only mode* to disable the release of extinguishant via automatic detection devices. EN12094-1 Section 4.23 option with requirements.

2. Safety and mounting

2.1 Safety

Suppliers of articles for use at work are required under section 6 of the Health and Safety at Work act 1974 to ensure as reasonably as is practical that the article will be safe and without risk to health when properly used.

An article is not regarded as properly used if it is used 'without regard to any relevant information or advice' relating to its use made available by the supplier.

This product should be installed, commissioned and maintained by trained service personnel in accordance with the following:

- (i) IEE regulations for electrical equipment in buildings
- (ii) Codes of practice
- (iii) Statutory requirements
- (iv) Any instructions specifically advised by the manufacturer

According to the provisions of the Act you are therefore requested to take such steps as are necessary to ensure that you make any appropriate information about this product available to anyone concerned with its use.

This equipment is designed to be operated from 24V DC supplies.

Status Units are environmental class A and are designed for indoor use only at temperatures between -5°C (+/- 3) and +40°C (+/- 2) and with a maximum relative humidity of 95%.

The IP rating for the enclosure is IP30.

Operation outside of these limits may render the equipment unsafe.

2.2 Mounting

Surface mounting Status Units should be mounted on a dry, flat surface, at eye height to the seven segment display and in a level position such that the enclosure is not distorted.

Screws or bolts of a minimum of 4mm diameter must be used to mount the enclosure in all four mounting positions.

Suitable fixings should be used at all fixing points such that the unit is securely mounted and is not liable to move once fixed.

Status Units should not be mounted in another enclosure or near sources of excessive heat.

Units can be flushed into a wall by fitting a flushing collar (part number M8FC) between the box and lid. This can be used on any standard Sigma Si status unit, but not the weatherproof version.

Cables should be connected using suitable cable glands. If additional cable entry points are required, all swarf and debris caused by drilling of additional cable entries must be cleared before power is applied to the Status unit.

Surface Mounting

Flush Mounting

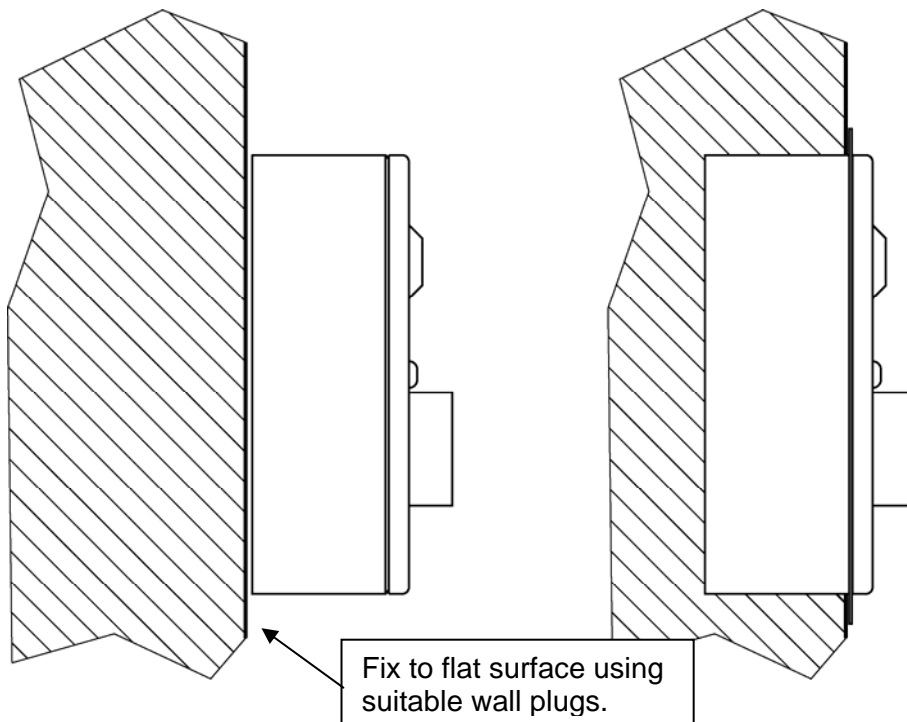

Figure 1. Mounting

3. Technical specification

Table 1 - Electrical specifications

Power supply	21 to 30 V DC	
Maximum current draw	0.07A	
Maximum number of status units	7	
Quiescent current	0.06A	
Terminal capacity	0.5mm ² to 2.5mm ² solid or stranded wire	
Monitored inputs end of line resistor	6K8 0.5W Resistor	<i>Supplied in terminals</i>
Monitored inputs normal threshold	8K ohm TO 1K ohm	
Monitored inputs trigger threshold	700 ohms to 100 ohms	
Monitored inputs Short circuit threshold	99 ohms to 0 ohms	
Data connection	Two wire RS485 connection (max 1200 metres)	<i>Maximum of 7 units- RS485 data cable</i>

4. Status Unit fascia

Depending on the type status units have LED indicators and controls as shown below.

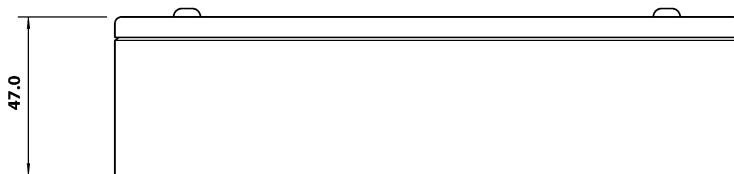
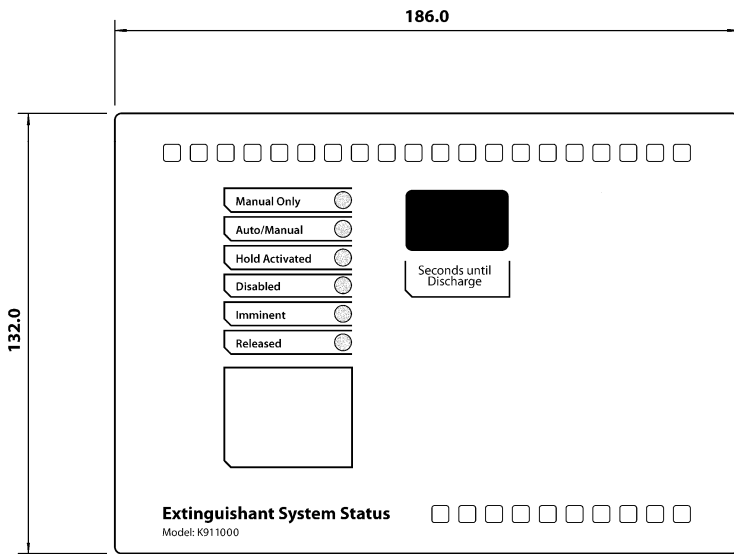

Model number K911000M8 surface
 Model number K911000F8 flush

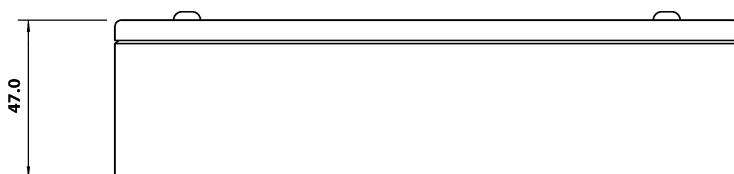
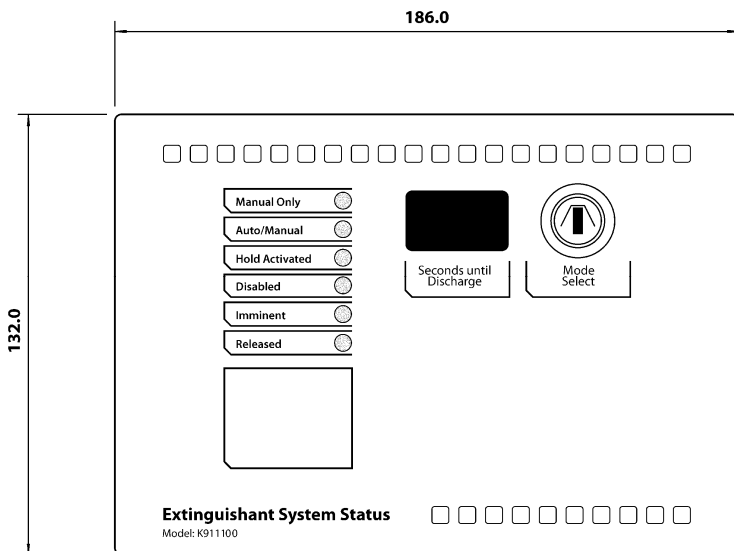

Model number K911100M8 surface
 Model number K911100F8 flush

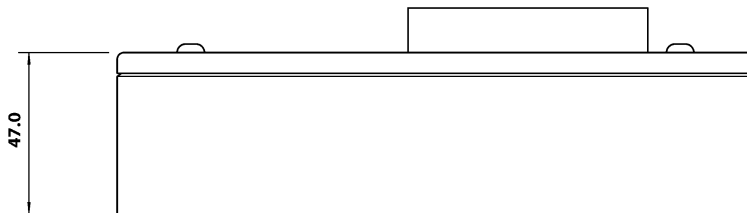
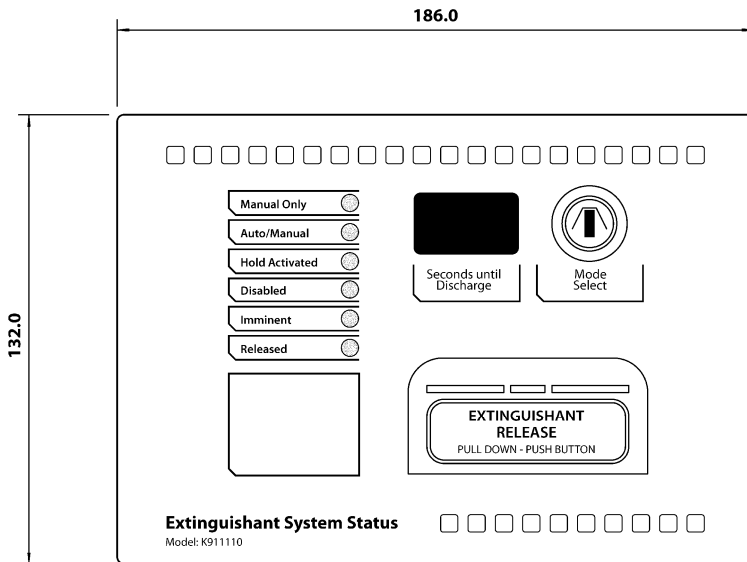

Model number K911110M8 surface
 Model number K911110F8 flush

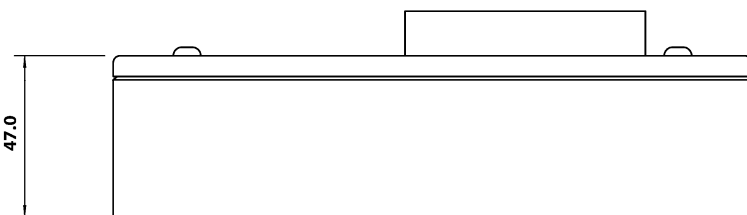
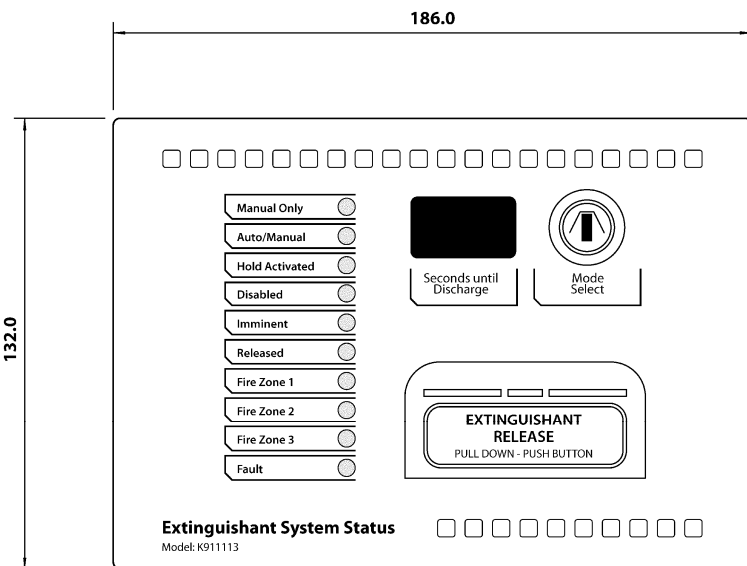

Model number K911113M8 surface
 Model number K911113F8 flush

5. Connecting to the circuit board

All connections for field wiring are to a single row of terminals along the side of the circuit board. Shielded fire alarm cable such as FP200 and metal cable glands must be used for all connections to the status unit. The resistance of any core of any cable must not exceed 25 ohms. The shield of the cable must be bonded securely to the enclosure via the metal gland.

Wiring should enter the enclosure at the top, bottom or back of the unit using the knockouts provided and be formed tidily to the appropriate terminals.

Terminals are capable of accepting wires of up to 2.5mm².

Wiring must not go across the front of the circuit board. If cable entries need to be in positions other than at the knockouts provided, wiring must be fed well away from the surface of the circuit board.

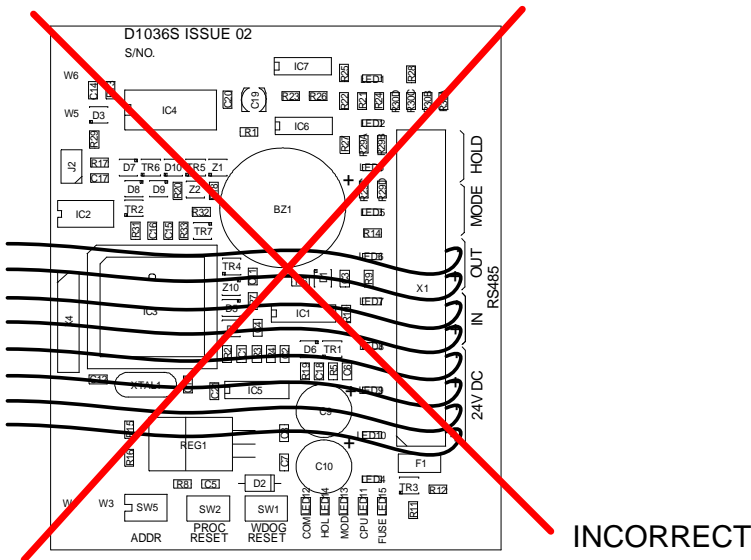
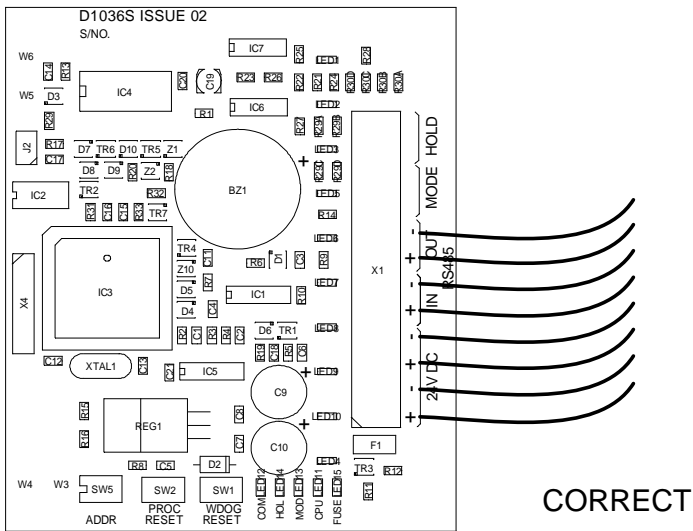
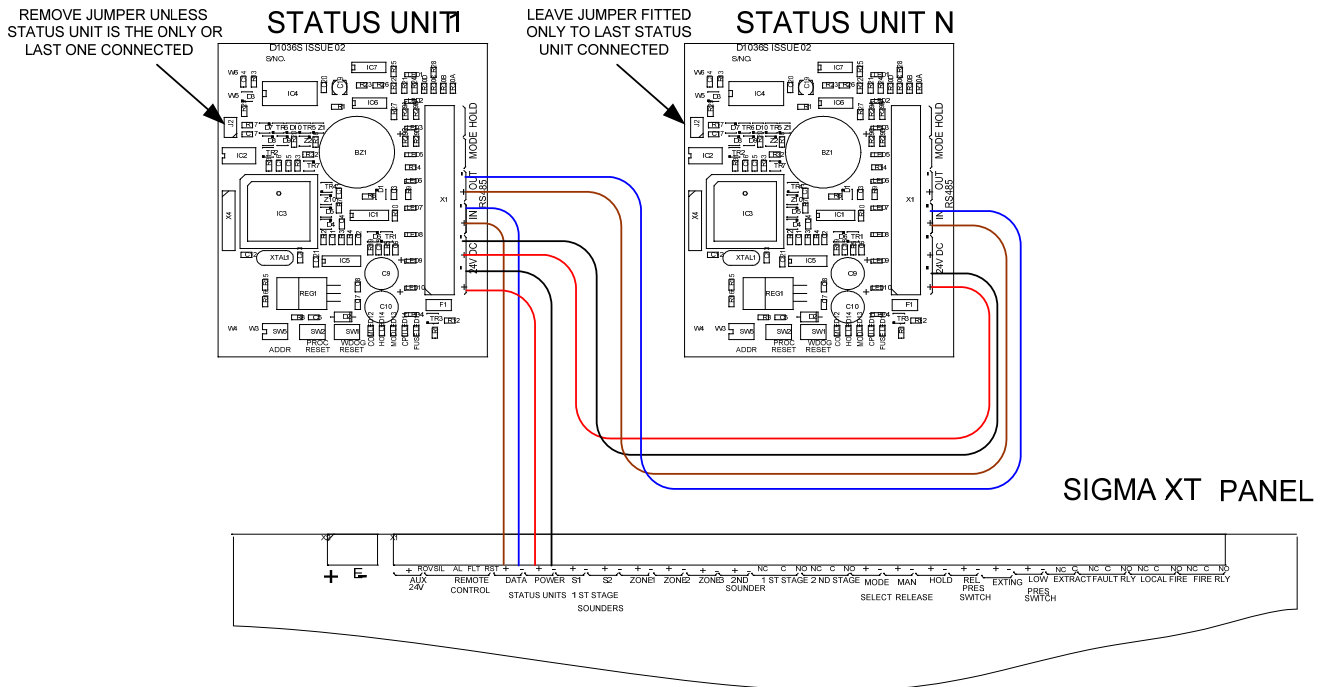

Figure 5 Wiring to the circuit board

6. Power and data connections

Each status unit requires two cores for power and two cores for data transmission to and from the control panel. A four core cable may be used for these connections. All of these connections are polarity conscious and care should be taken to match the polarity with the corresponding terminals at the control panel.



Data Termination

Up to seven status units can be connected to an extinguishant control panel. In and out terminals for data and 24V DC are provided on each unit.

All status units are supplied with a push on jumper fitted at position J2 on the left hand side of the PCB. This jumper connects a terminating resistor which needs to be in place at the last status unit on the data line. If more than one status unit is to be fitted then the jumpers must be removed from all status units except the last one.

If there is only one status unit fitted then the jumper should be left in place.

7. Connection to Hold and Mode inputs

Status units have monitored inputs to which remote Hold or Mode select switches can be connected.

These inputs are monitored for open and short circuit faults and therefore need to have a 470R 1W trigger resistor connected in series with the activating, normally open switches and 6K8 0.5W end of line monitoring resistors connected across the end of the cables.

The 6K8 end of line monitoring resistors are supplied fitted to the Hold and Mode input terminals and the 470R trigger resistors are supplied in the accessory bag with the status unit.

If either of these inputs are not being used then the end of line monitoring resistors should be left in the Hold and/or Mode terminals.

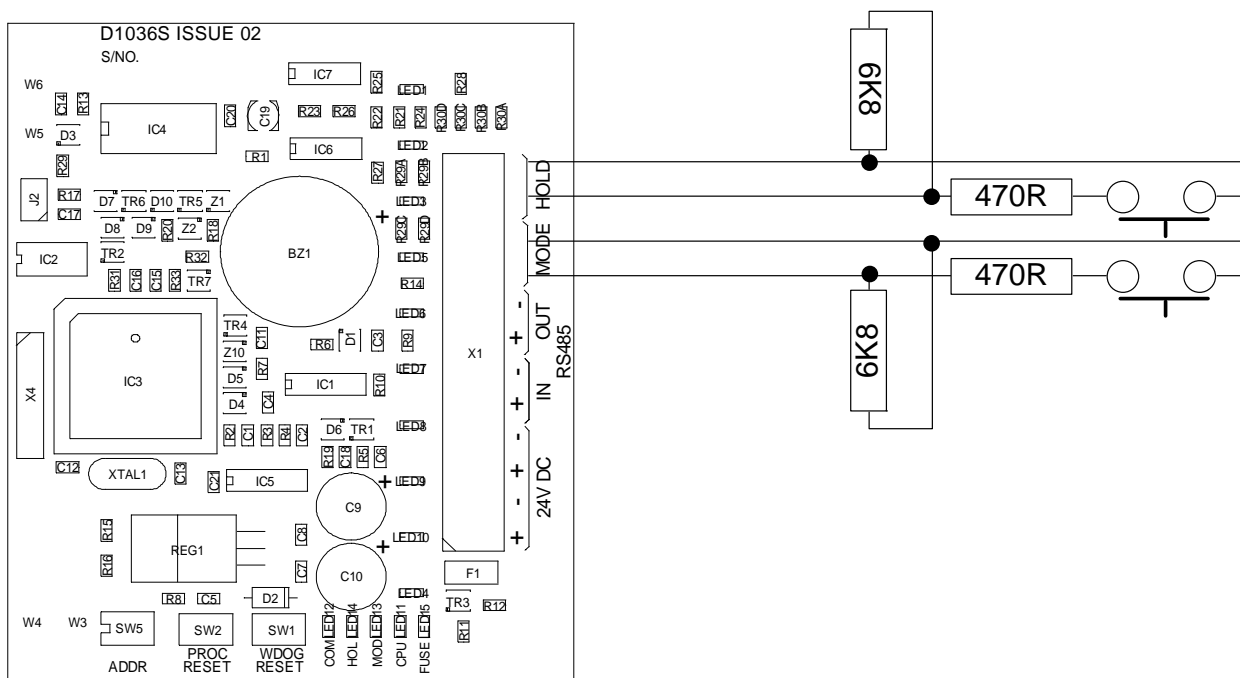

8. Mode input

The mode input is provided to allow connection of remote Mode select keyswitches or to connect to door interlock contacts. The system is designed such that any Manual only mode input on the system that is active (input operated by 470R trigger resistor) will put the system into Manual only mode regardless of the status of any other Mode inputs. Therefore, for the system to be in Automatic and manual mode, all Mode inputs must be inactive.

Indication of the Mode is given on the front of the status unit by the Manual only or Automatic and manual LEDs.

9. Hold input

When active (input operated by a 470R trigger resistor) the Hold input allows the extinguishant release countdown timer to be reset to its maximum time. When the input is de-activated the countdown to extinguishant release will re-start at the maximum time that is configured at the panel (0 to 60 seconds).

IMPORTANT NOTE: When there is a fault on the HOLD input then the HOLD function is invoked which means that the extinguishant release will not operate until this condition is cleared.

10. Mode select keyswitch

Some models of the status units have a mode select keyswitch. The key can be removed in either position. The operation of the Mode select keyswitch is as per the Mode input above.

11. Manual release

Some models of the status units are fitted with a manual release button. This replicates the action of the manual release control at the main control panel and once activated will start the extinguishant release sequence.

A plastic seal is provided in the accessory pack and should be fitted to the manual release flap with a piece of thin wire to provide an indication if the manual release has been tampered with.

12. Addressing status units

To enable the control panel to know whether any status units that should be connected have been disconnected and indicate a fault condition, each status unit must be allocated and address. The address switch should never be set with all switches off.

This is done by setting a binary number from 1 to 7 on the 3 way, DIL switch located at the bottom of the status unit PCB.

The order of the addresses is not important but each status unit must be allocated a different address.

The switch settings for each of the addresses are shown below.

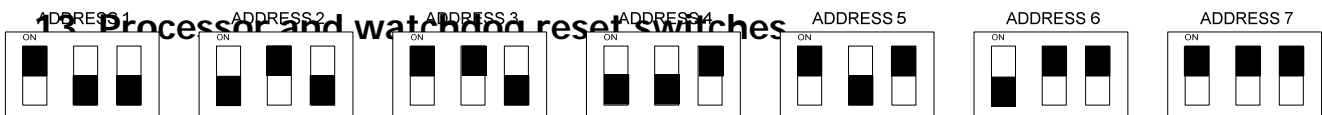

The status unit is controlled by a microprocessor, which will re-start itself and continue to run if it stops for any reason such as severe electrical interference such as an electrical storm.

To ensure that the unit is not being subjected to continual, undue interference which may effect its proper operation, a CPU fault indicator is latched on and a fault condition signalled to the control panel.

If a processor re-start has occurred this latched fault condition will need to be reset by pressing the WDOG RESET button on the bottom of the PCB.

A switch is also provided to manually re-start the processor PROC RESET. This switch can be used while the status units are connected to the system to ensure that the unit starts up and establishes communication with the panel in a controlled and expected manner.

14. Internal fault

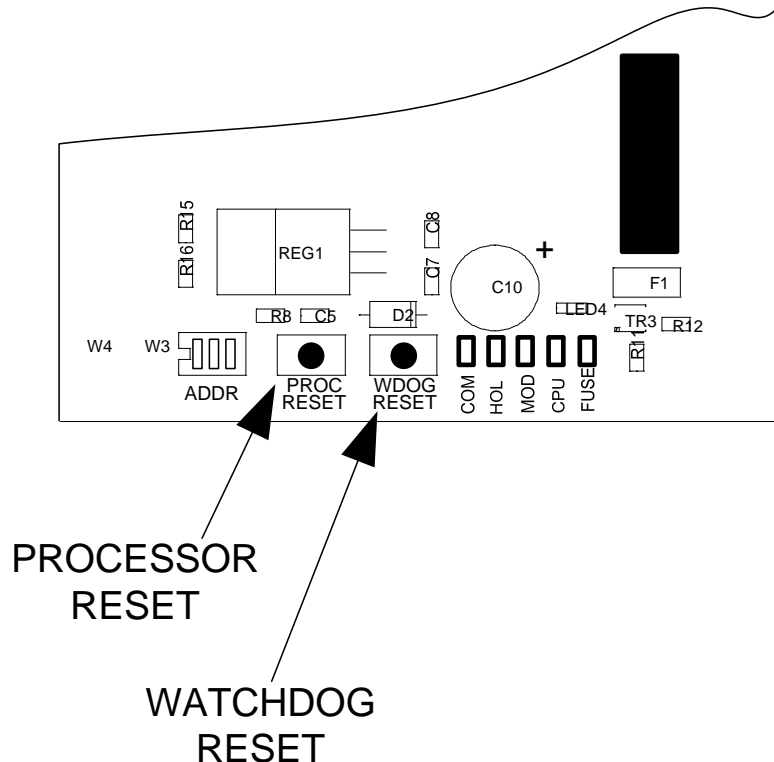

indications

An extinguishant fault indication at the control panel may mean that there are faults at one or more status units. The status unit fault indications are located along the bottom of the PCB and are as follows:

14.1 COM

This LED indicates that the data communications connection to the control panel is not present. This may be because the data lines are connected with reverse polarity or are not connected. Check RS485 IN and OUT connections.

14.2 HOL

This LED indicates that the HOLD input is open or short circuit. Check that the correct end of line resistor is connected to the HOLD terminals or at the end of the wires connected to the HOLD input and that the HOLD input is not short circuited.

IMPORTANT NOTE: When there is a fault on the HOLD input then the HOLD function is invoked which means that the extinguishant release will not operate until this condition is cleared.

14.3 MOD

This LED indicates that the MODE input is open or short circuit. Check that the correct end of line resistor is connected to the MODE terminals or at the end of the wires connected to the MODE input and that the MODE input is not short circuited.

14.4 FUSE

This LED indicates that the electronic fuse has operated. Under this condition, the status unit is not operational. This may be due to incorrect polarity of the power connection or a failure on the unit itself.

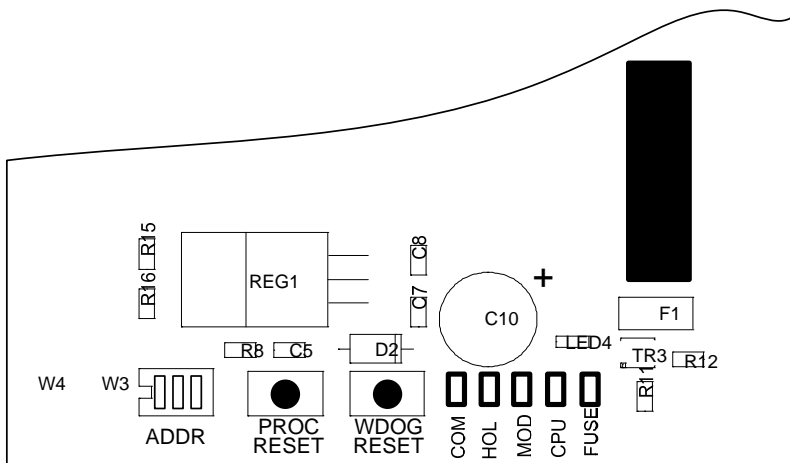

**FAULT
INDICATIONS**

15. Adding new status units/ancillary boards

When the system is powered, it will search for connected status units.

When new or additional status units are added to the system, these will be shown on the display when the system is first powered.

Status units are shown as **Pux** (where x is the address of the unit found).

The select key can be used to view all of the status units that the system has found.

These should be checked to ensure that the same number of devices that have been fitted, are found by the system.

For the system to accept these into its memory, the procedure below must be followed.

1. Operate the Enable Controls keyswitch.
2. Enable the Write Enable Switch (push to the right) – Access level 3.
3. The display will show **Pux** for status units that are found (where x is the address of each unit) and the dot in the display will be flashing. Operate the Enter button which will accept the displayed unit and step through to the next unit found.
4. When the Enter button does not step on to any other units, all devices have been accepted.
5. Disable the Write enable switch (push to the left).
6. Disable the Enable controls keyswitch.
7. The panel should return to the normal, quiescent condition.

16. Removing status units

When status units are to be removed from the system, the system must be powered down first and the status units removed. The system should then be powered. When the system starts it will be in fault and the units removed will be shown on the display. Status units are shown as **Fux** (where x is the address of the unit). The Select button can be used to view all of the status units that the system expects to be found but are now missing.

For the system to accept the removal of these devices from its memory the following procedure must be carried out.

1. Operate the Enable Controls keyswitch.
2. Enable the Write Enable Switch (push to the right) – Access level 3.
3. Wait for the General fault LED to illuminate
4. Disable the Write enable switch (push to the left)
5. Disable the Enable controls keyswitch
6. The panel should return to the normal quiescent condition.

If the panel fails to receive messages from a status unit after it has been stored in the configuration memory, the internal “comms fault” LED will light and a fault condition will be displayed on the panel fascia. The seven segment display on the panel will show the number of the unit that is disconnected and all LEDs on the status unit that is disconnected will flash.